

INSTRUKCJA MONTAŻOWA

Wskazówka dotycząca pielęgnacji!

Proszę czyścić tylko suchą lub lekko wilgotną szmatką do kurzu.
Nie używać żadnych środków szorstkich!

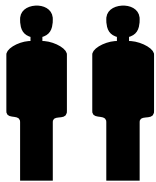

ASSEMBLE DIFFICULTY:

1 2 3 4 5

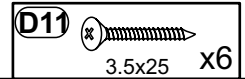
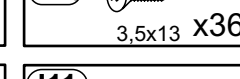
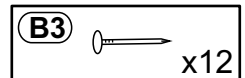
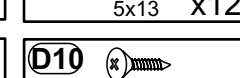
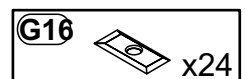
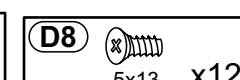
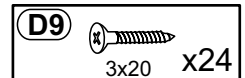
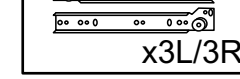
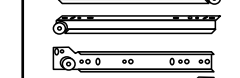
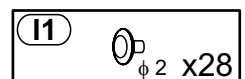
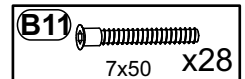
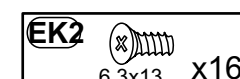
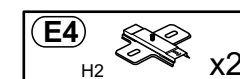
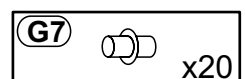
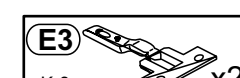
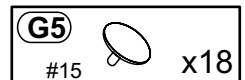
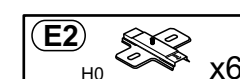
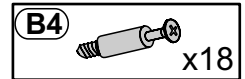
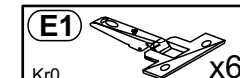
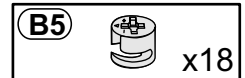
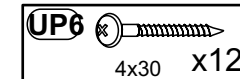
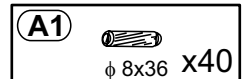
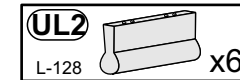
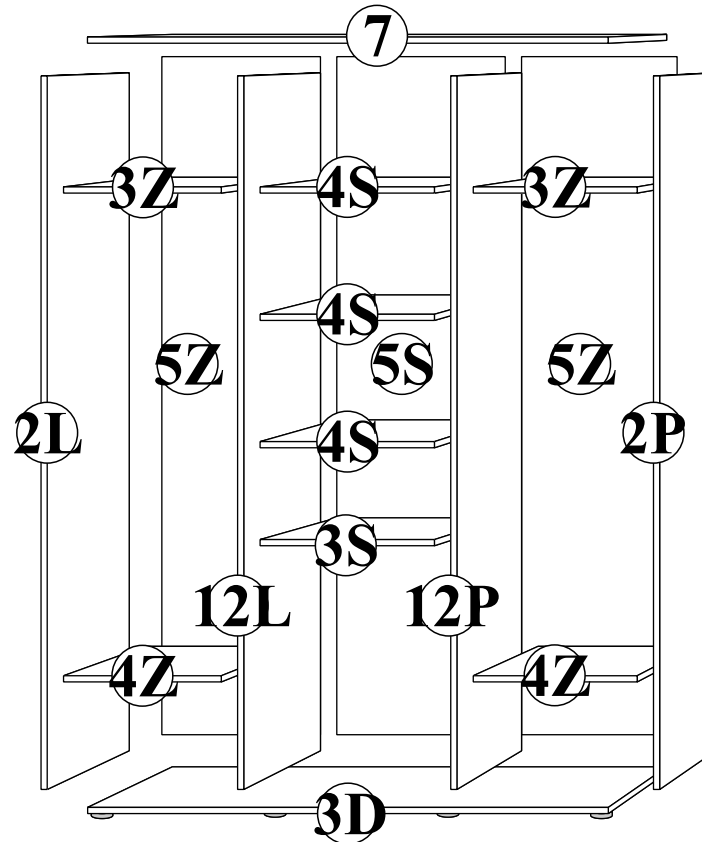
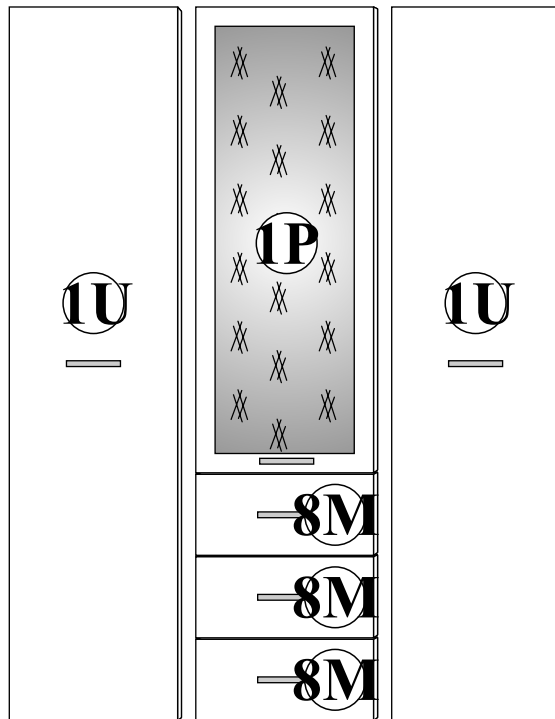
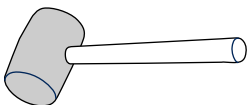
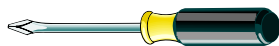
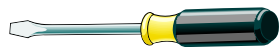
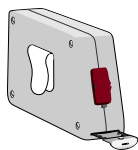

Maksymalne obciążenie półek w kg:

Dł.	mm	Płyta		
		15	18	22
0<400				
401<600		40	40	40
601<800		24		
801<1000		15	30	

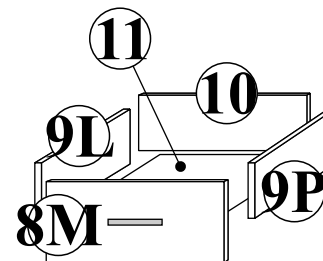
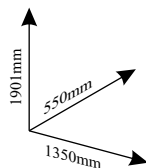

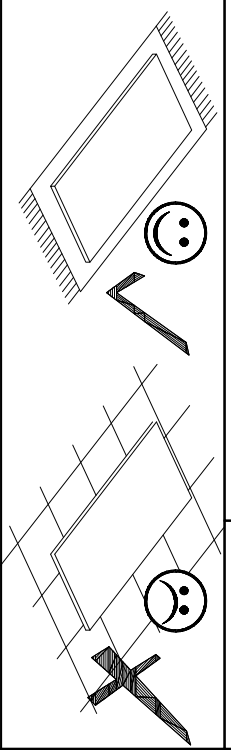
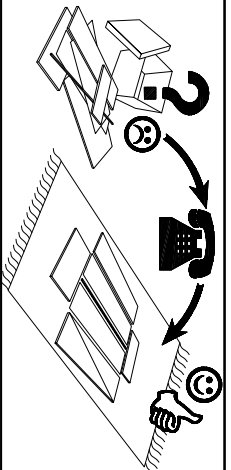

Wskazówki bezpieczeństwa

FR

1. Nettoyez à sec ou à l'aide d'un chiffon humide. N'utilisez pas de poudre à récurer ou tout autre détergent agressif.
2. Produit n'est pas adapté pour un usage extérieur.
3. Il ne faut pas dépasser la charge maximale mentionnée dans la notice de montage : le meuble risque d'être abimé ou endommagé.
4. Protégez le meuble contre l'eau (p. ex. pendant l'arrosage des plantes et le nettoyage) : l'humidité peut pénétrer dans le meuble et l'endommager.
5. Mettez tous les emballages hors de la portée des enfants! Danger d'étouffement ou de blessure.

NLT

1. Reinig allen met een stofdoek off een lichtjes vochtige doek. Gebruik geen schurende poetsmiddelen.
2. Het product is niet geschikt voor het gebruik in open lucht.
3. Overschrijd de aangegeven maximale belastingen niet. Anders kan het meubelstuk worden beschadigd of vernield.
4. Bescherm uw meubelen doorgaans tegen water (bijv. bij het dwellen of als u de bloemen water geeft). De vochtigheid kan in het meubelstuk dringen en het beschadigen.
5. Het artikel is geen speelgoed voor kinderen! Zorg ervoor dat kinderen ook niet met de verpakking spelen. Ze kunnen stikken door de folie of zich verwonden aan de verpakking.

PL

1. Czyszczenie należy wykonać wyłącznie za pomocą ściereczki lub lekko nawilżonego ręcznika. Nie stosować środków czyszczących do szorowania.
2. Produkt nie jest przystosowany do zastosowań na wolnym powietrzu.
3. Nie wolno przekraczać podanych maksymalnych wartości obciążenia. W innym przypadku można mebel uszkodzić lub zniszczyć.
4. Mebel należy chronić przed wodą (np. podczas czyszczenia lub podlewania kwiatów). Wilgoć może wnikać w mebel i uszkodzić go.
5. Produkt nie służy do zabawy! Dzieci nie powinny bawić się opakowaniem produktu, gdyż mogą się udusić folią lub skałeczyc opakowaniem.

GB

1. Please only clean with a duster or a damp cloth. Do no use any abrasive cleaners.
2. The product is not suitable for outdoor use.
3. Do not exceed the maximum loads specified. Otherwise, the furniture may sustain damage or be irreparably damaged.
4. In general, keep water away from your furniture (e. g. when mopping or watering plants). The moisture may penetrate the furniture and damage it.
5. This product is not a toy! Do not allow children to play with the packaging. They could suffocate in the foil or injure themselves on the packaging.

TR

1. Lüften sadece bir toz bezilye veya hafif nemli yumuşak bir bezle siliniz. Aşındırıcı temizlik malzemeleri kullanmayınız.
2. Bu ürün açık havada kullanılmaya uygun değildir.
3. Belirtilen azami yük değerini aşmayınız, aksi takdirde mobilya parçası zarar görebilir veya kullanılamaz hale gelebilir.
4. Genelde mobilyalarınızı sudan koruyunuz (örneğin, yerleri paspaslarken veya çiçekleri sularken). Nem, mobilya parçasına nüfuz edebilir ve zarar verebilir.
5. Bu ürün bir çocuk oyuncacı değildir! Çocukların ürün ambalajlarıyla oynamalarını asla müsaade etmeyiniz. Çocuklar, folyo nedeniyle boğulabilir veya ambalaj nedeniyle yaralanabilirler.

D

1. Bitte nur einem Staubtuch oder leicht feuchtem Lappen reinigen. Keine scheuernden Putzmittel verwenden.
2. Das Produkt ist nicht für die Anwendung im Freien geeignet.
3. Überschreiten Sie die angegebenen Maximalbelastungen nicht. Andernfalls kann das Möbelstück beschädigt oder zerstört werden.
4. Schützen Sie Ihre Möbel generell vor Wasser (z.B. beim Wischen oder Blumen gießen). Die Feuchtigkeit kann in das Möbelstück eindringen und es beschädigen.
5. Der Artikel ist kein Kinderspielzeug! Lassen Sie Kinder auch nicht mit der Verpackung spielen. Sie könnten an der Folie ersticken oder sich an der Umverpackung verletzen.

1

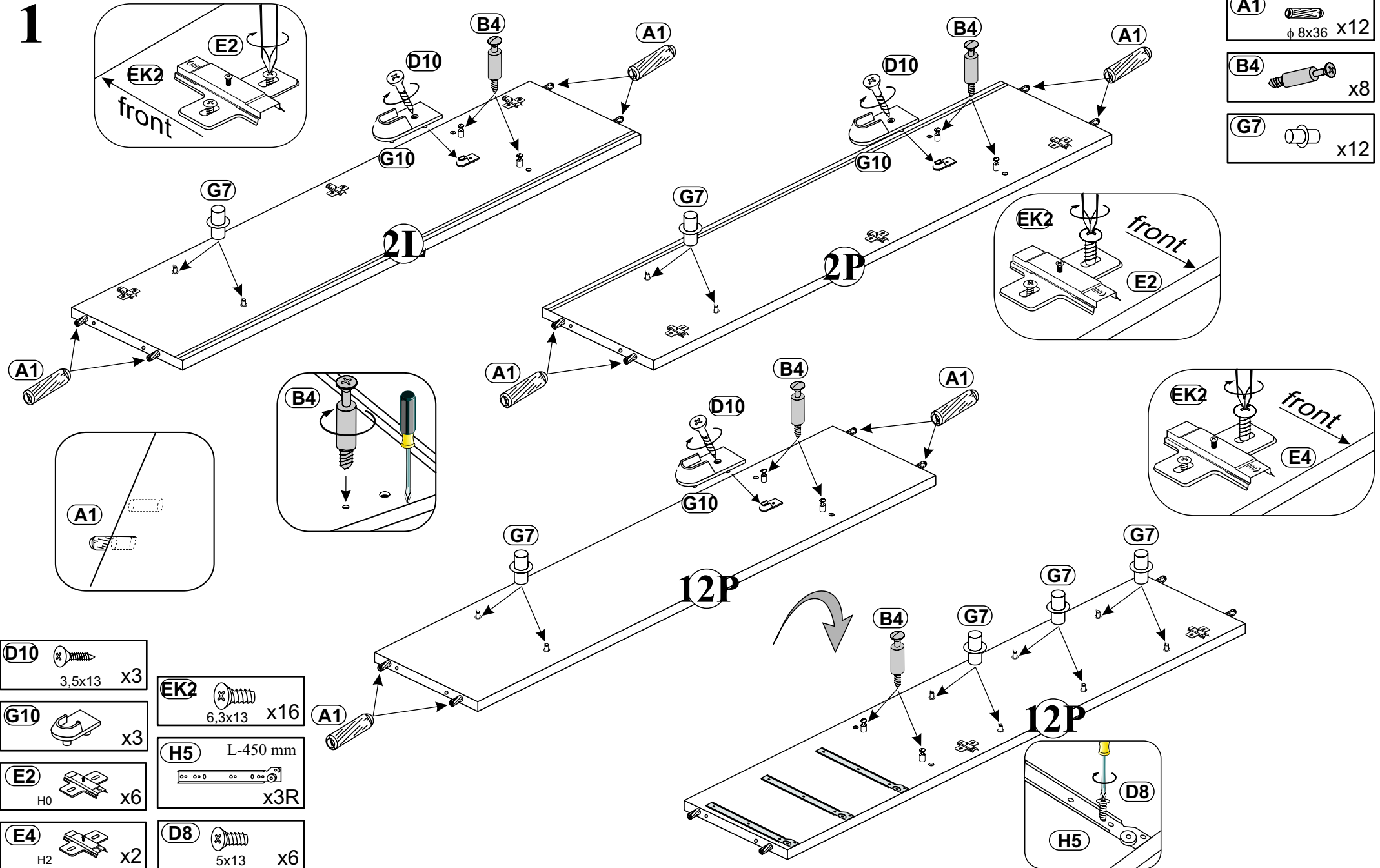



A1  ϕ 8x36 x12

B4  x8

G7  x12

D10  3,5x13 x3

G10  x3

E2  H0 x6

E4  H2 x2

EK2  6,3x13 x16

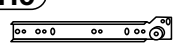
H5 L-450 mm
 x3R

D8  5x13 x6

D8  **H5**

2

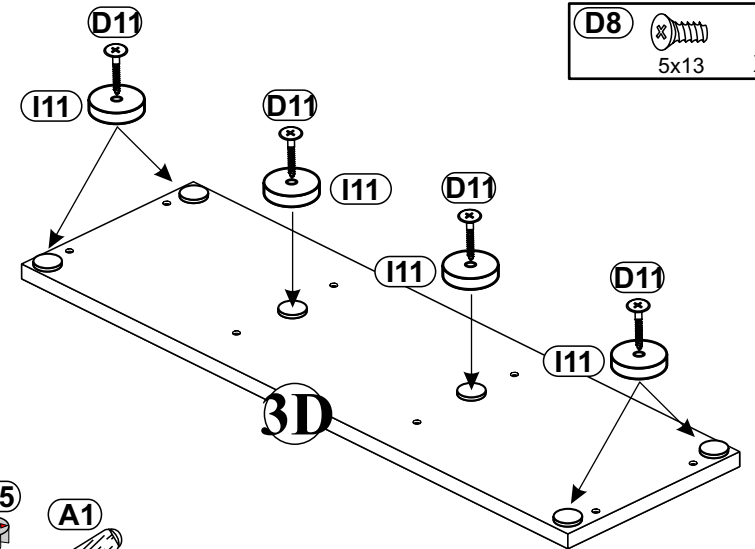
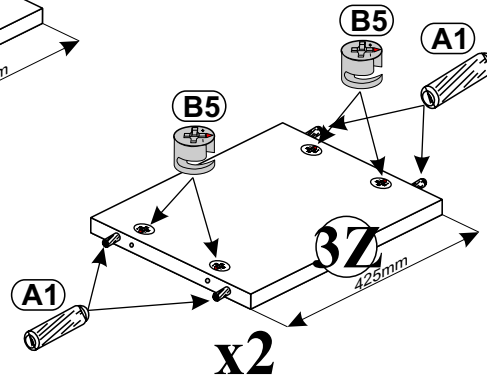
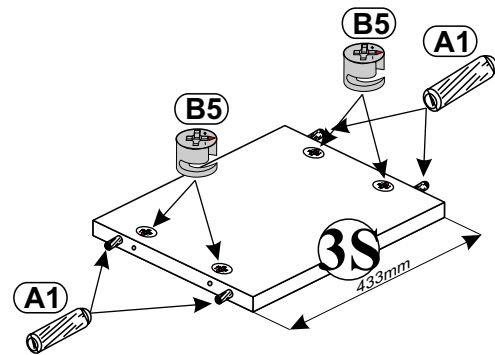
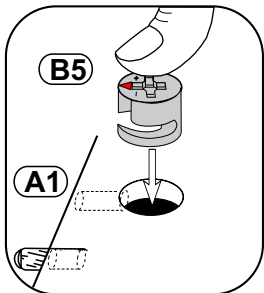
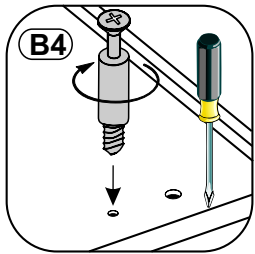
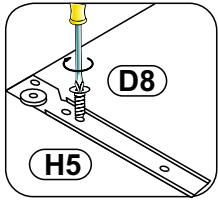
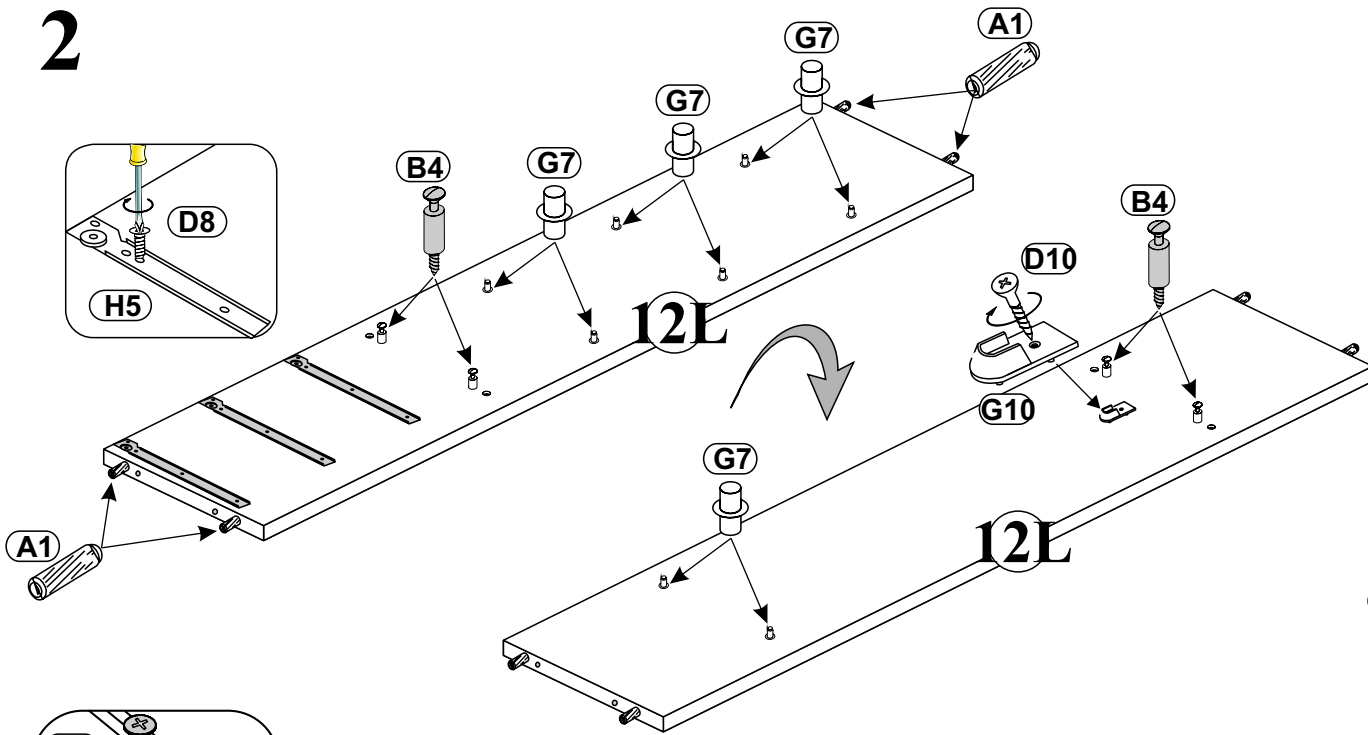



I11  x6

A1  ϕ 8x36 x16

D11  3.5x25 x6

B5  x12

G10  x1

B4  x4

D10  3.5x13 x1

G7  x8

H5 L-450 mm
 x3L

D8  5x13 x6

DINO 4

SZAFA 3D

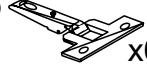

3

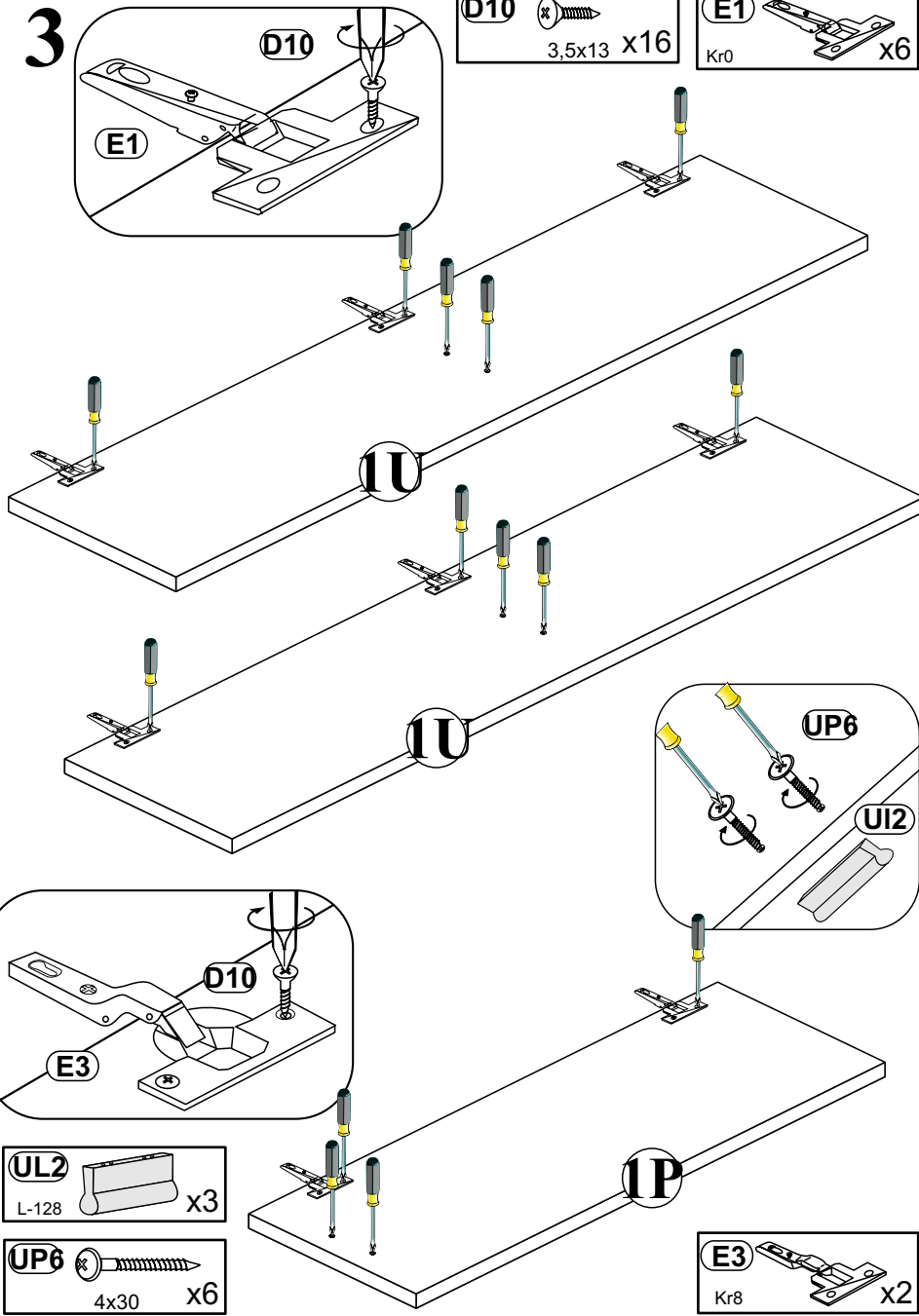



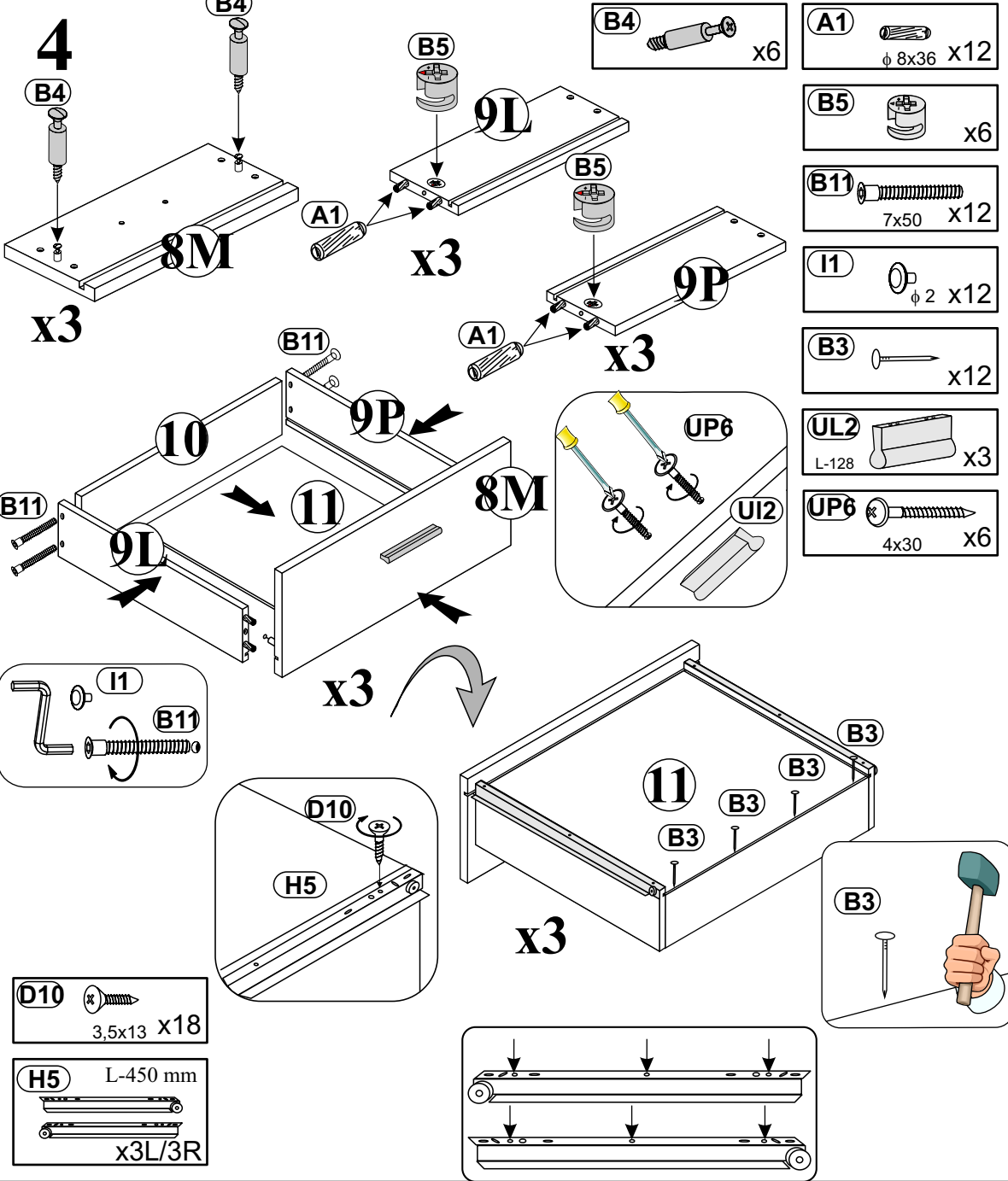

- D10**  3,5x13 x16
- E1**  Kr0 x6



4

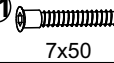

- D10**  3,5x13 x18
- H5**  L-450 mm x3L/3R

- A1**  ϕ 8x36 x12
- B5**  x6
- B11**  7x50 x12
- I1**  ϕ 2 x12
- B3**  x12
- UL2**  L-128 x3
- UP6**  4x30 x6

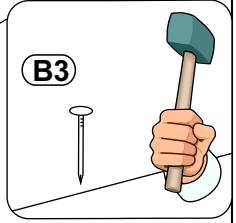

DINO 4

SZAFA 3D

5

6

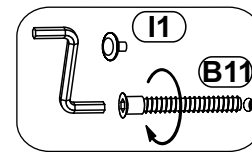
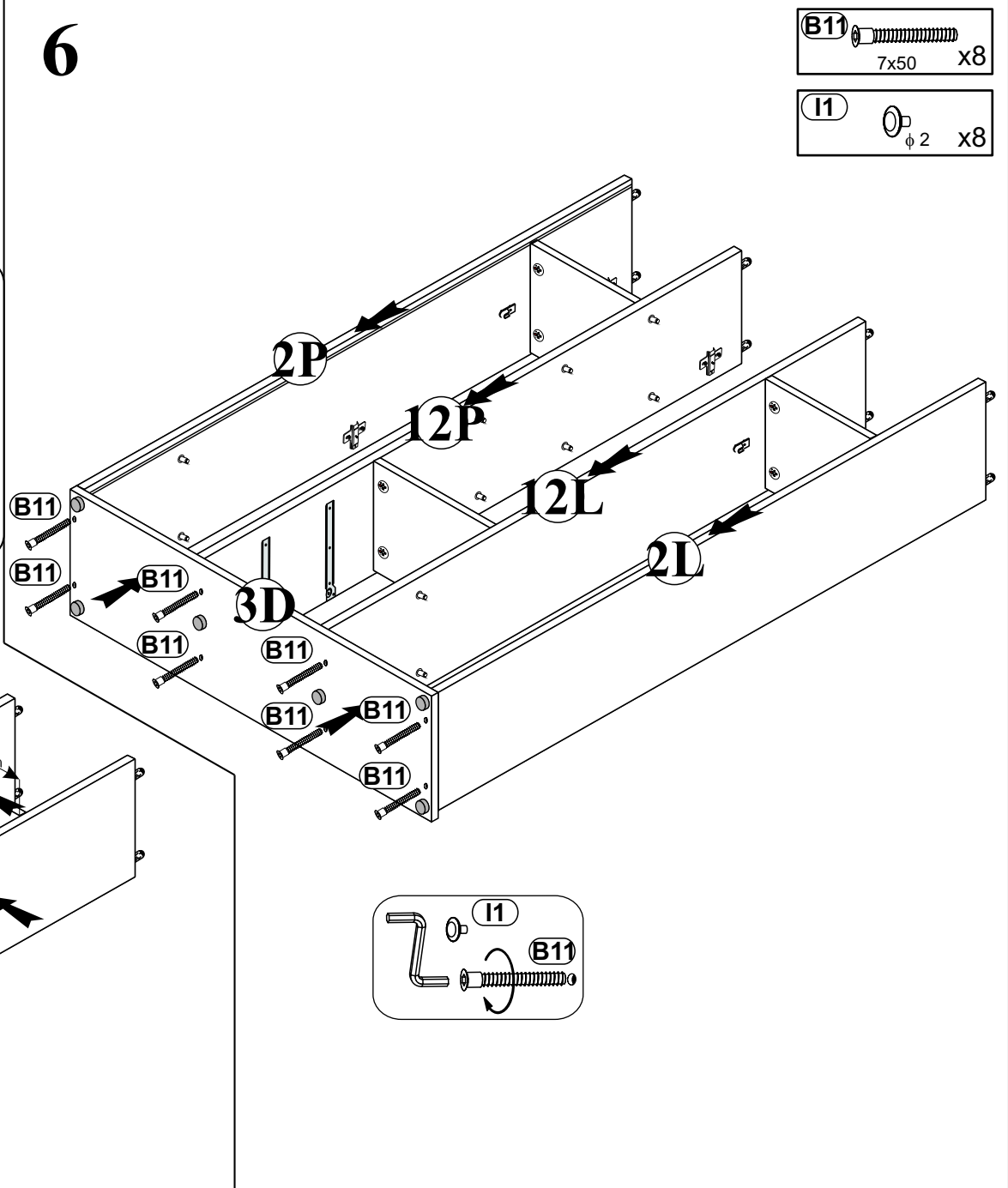
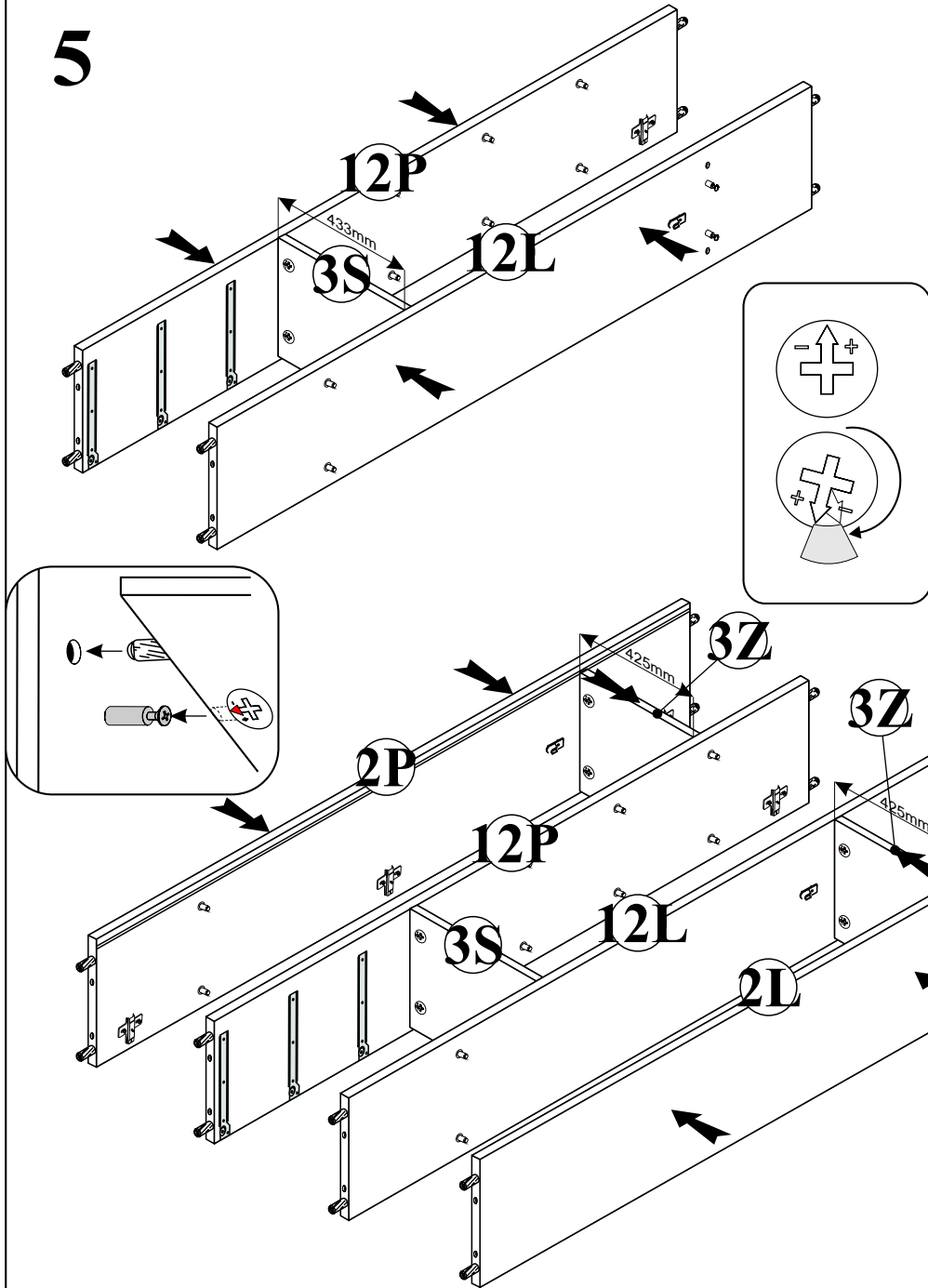
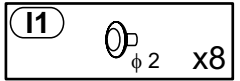
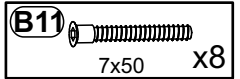

7

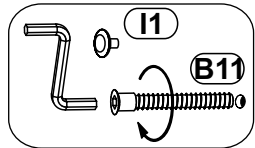
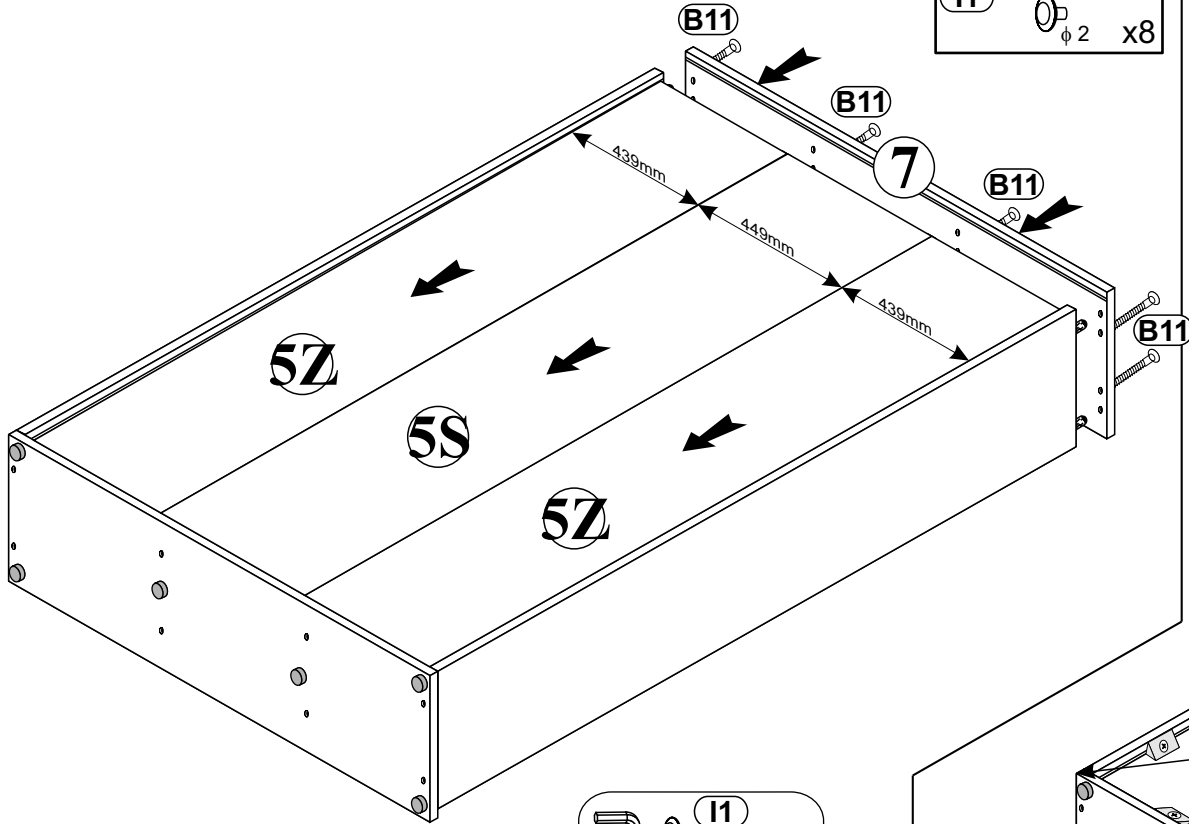
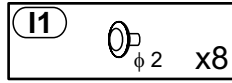
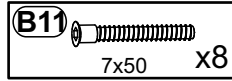

8

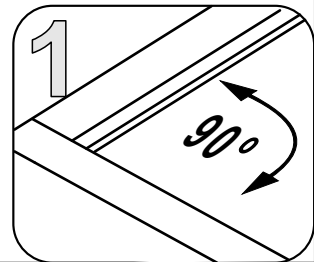
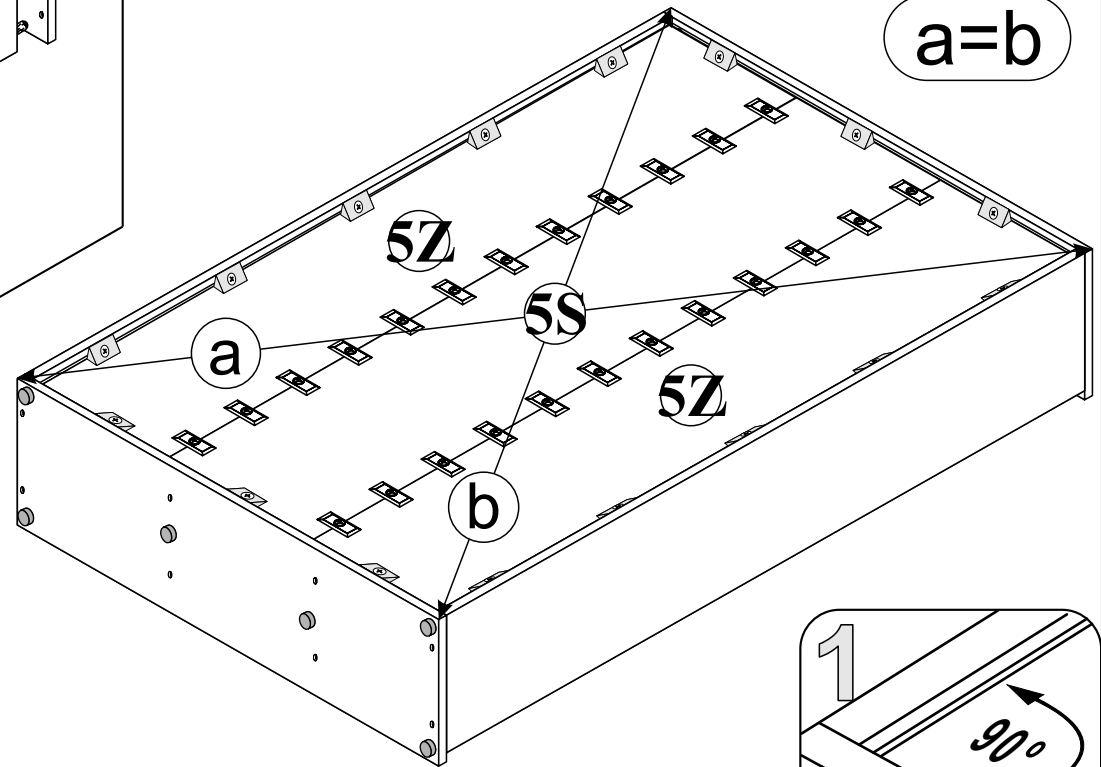
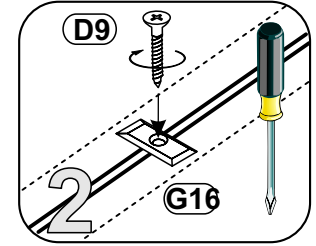
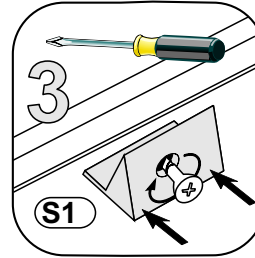
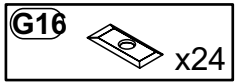
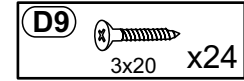

DINO 4

SZAFA 3D

9

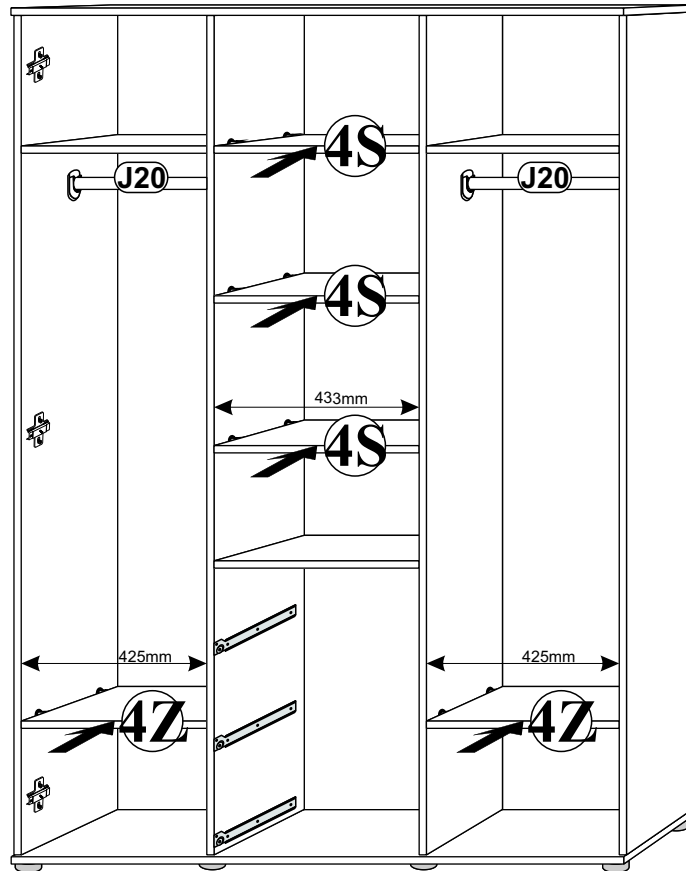
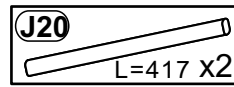
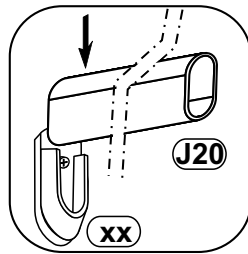

10

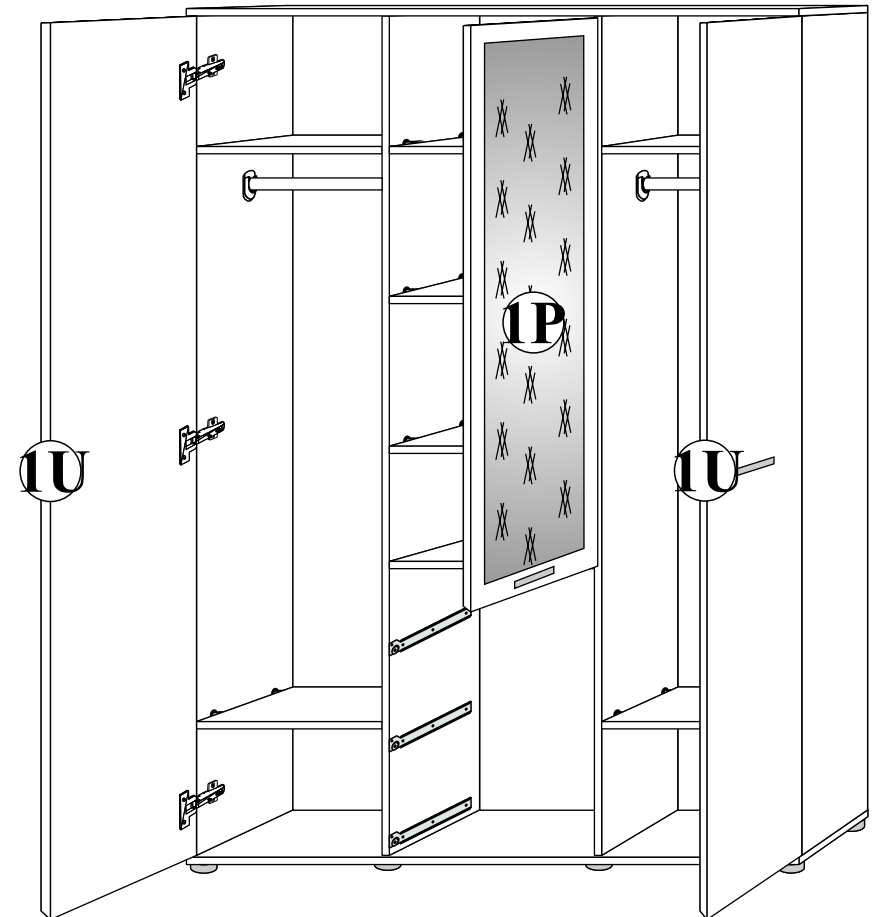
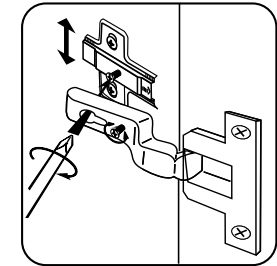
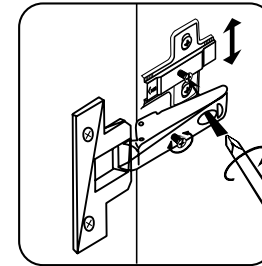

11

G5
#15 x18

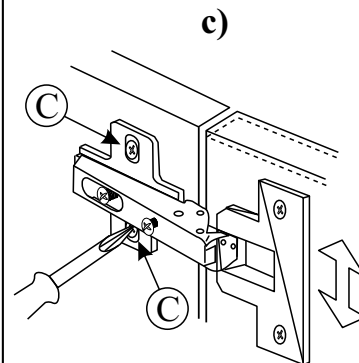
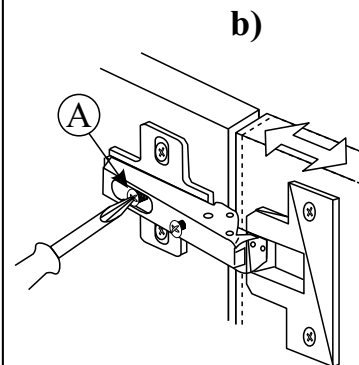
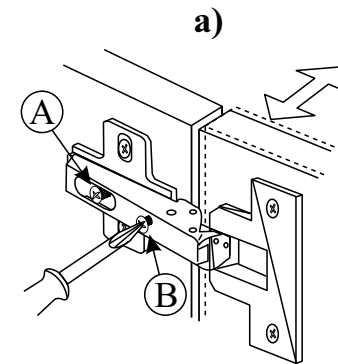
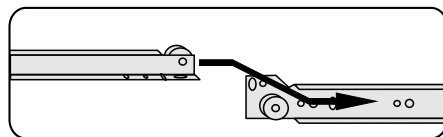
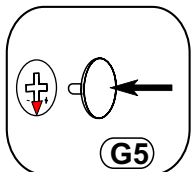
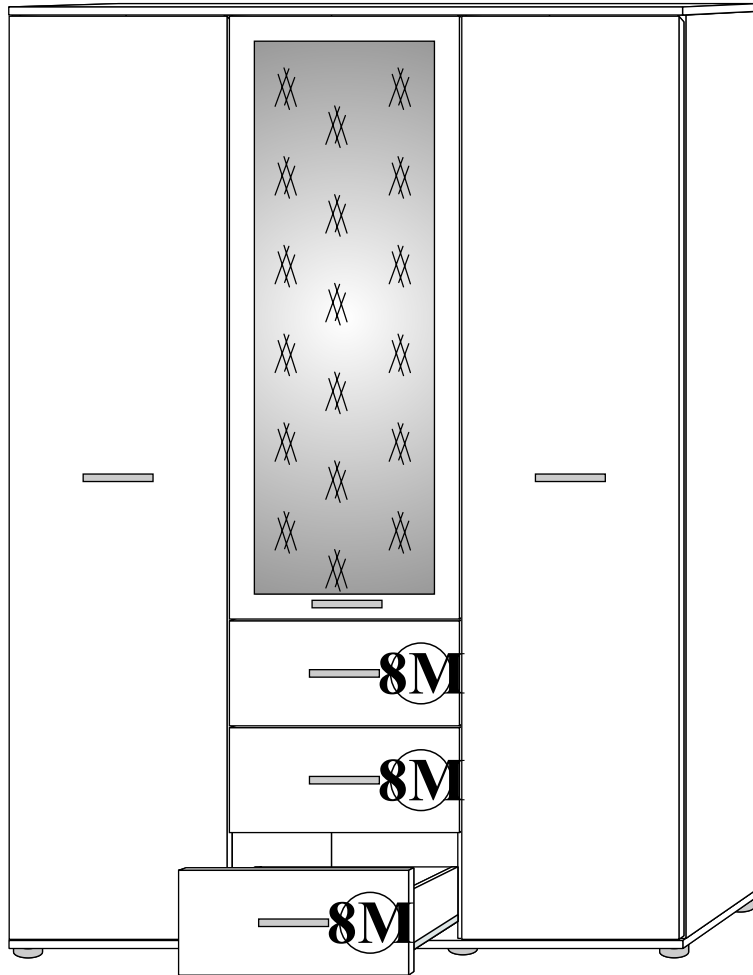

Verstellmöglichkeiten

- a) Fugenverstellung:
Befestigungsschraube "A" lockern, gewünschte Fuge mit Schraube "B" einstellen, Schraube "A" anziehen.
- b) Tiefenverstellung:
Befestigungsschraube "A" lockern, Bandarm nach vorne oder rückwärts verschieben, Schraube "A" anziehen, Schraube "B" mit einer 1/4 Drehung nach rechts arretieren.
- c) Höhenverstellung:
Befestigungsschraube "C" lockern, Höhe einstellen, Schraube "C" anziehen.

Instructions for hinge adjustment

- a) Side adjustment:
Loosen fixing screw "A", adjust gap with screw "B" and retighten screw "A".
- b) Depth adjustment:
Loosen fixing screw "A", push hinge arm forwards or backwards, retighten screw "A", fix screw "B" with a 1/4-turn in clock-wise direction.
- c) Height adjustment:
Loosen screw "C", adjust height, retighten screw "C".

Les possibilités de positionnement

- a) Positionnement de la rainure:
Desserrer la vis de fixation "A", positionner avec la vis "B" la rainure (joint) souhaitée et resserrer la vis "A".
- b) Positionnement de la profondeur:
Desserrer la vis de fixation "A" (1 tour), régler la profondeur et resserrer la vis "A".
- c) Positionnement de la hauteur:
Desserrer la vis de fixation "C" (1 tour), positionner la hauteur et resserrer la vis "C".

Możliwości regulacji

- a) Regulacja szczeliny:
Poluzować wkręt "A", wkrętem "B" ustawić odpowiednią szczelinę, dokręcić wkręt "A".
- b) Regulacja głębokości:
Poluzować wkręt "A" (1 obrót), ustawić głębokość, dokręcić wkręt "A".
- c) Regulacja wysokości:
Poluzować wkręt "C" (1 obrót), dokonać regulacji wysokości położenia drzwi, wkręt "C" dokręcić.